

# User manual

## Hoof trimming crush

SA0026



Manufacturer:

Wopa Constructiebedrijf BV  
Rector Hulshofstraat 10  
7135 JV Harreveld  
The Netherlands

: +31-(0)544 372415  
: +31-(0)544 372445  
Email: [info@wopa.com](mailto:info@wopa.com)  
Website: [www.wopa.com](http://www.wopa.com)

© Copyright 2026

No part of this publication may be reproduced, stored in a search system or transferred in any form whatsoever, either electronically or mechanically, or by photocopying or recording, or in any other way whatsoever without prior written consent from Wopa Constructiebedrijf BV (hereinafter in this manual also referred to as "Wopa").

## Introduction

Wopa Constructiebedrijf BV specialises in development and manufacture of hoof trimming and treatment crushes for cows and bulls for professional users as well as for cattle farmers.

Our crushes are developed and manufactured in the highest possible quality, according to the strictest requirements as far as safety, user convenience, animal welfare and hygiene are concerned, always striving for an optimum.

This manual contains information and instructions relevant to installation, operation and maintenance of the machine.



- The machine is not suitable for use in explosive hazardous environments.
- All persons responsible for operation must, at minimum, read and comprehend the sections on operation and safety of these operating instructions.
- All persons responsible for assembly, installation, maintenance and/or repair must read and comprehend all these operating instructions.
- The user is responsible for interpretation and use of this manual under all conditions. Should you have any doubts or questions regarding the correct interpretation, please contact the owner or the supervisor.
- Keep this manual nearby the installation and within the users' reach.
- Keep a log of all major maintenance work, adaptations to the installations and observations, see Annex 8.1.
- Changes to the installation/machine are not permitted without prior written approval from the supplier.
- Contact the supplier for any special maintenance work not included in this manual.
- Comply with the safety requirements as given in Section 3 at all times.
- Proper functioning as well as the safety of the system can only be guaranteed if the recommended maintenance is carried out correctly and on time.

Manufacturer/Supplier: WOPA Constructiebedrijf BV  
 Address: Rector Hulshofstraat 10  
 Postcode/Town: NL-7135 JV Harreveld  
 Telephone: +31(0)544 372415  
 Email: info@wopa.com

Machine name: Hoof trimming crush  
 Year of construction: 2026  
 Type number: SA0026  
 Serial number: 00..

<b>WOPA</b>		Rector Hulshofstraat 10 NL-7135 JV Harreveld The Netherlands		www.wopa.com info@wopa.com Tel: +31 544 37 24 15		<b>CE</b>		
Type	SA0026	Machine	Claw Treatment Crush					<b>UK</b>
Serial no.	xxxxx	Watts	...V / ..Hz	kW	Hz	50		
Total weight	xxxxx kg	Voltage	.... V	Year	....	2026		

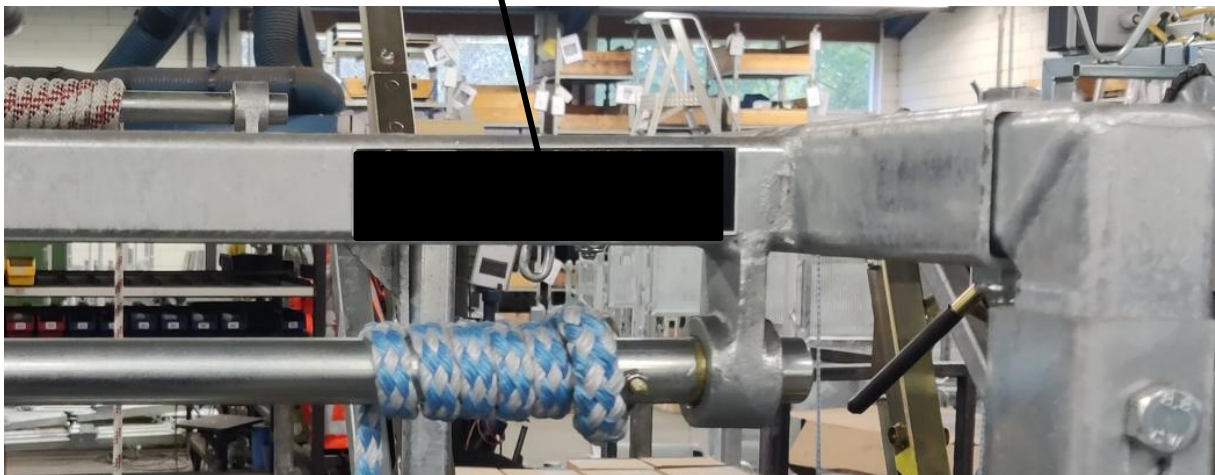

## Warranty

The warranty is subject to the following limitations. The warranty period for products supplied by Wopa is 12 months from the date on the purchasing document. The warranty is limited to production and material errors and therefore does not cover any breakdowns due to a part of the product exposed to any type of wear. Normal wear as can be expected from using this product is therefore excluded.

1. Wopa's responsibility remains limited to replacing defective parts; we recognise no claims to any other type of loss or costs.
2. The warranty is automatically void in case of overdue or poorly implemented maintenance.
3. Should you have any doubts regarding maintenance work or should the machine fail to operate correctly, contact the supplier.
4. The warranty does not apply if the defect is the result of incorrect or negligent use or of maintenance carried out contrary to the instructions in this manual.
5. The warranty is void if any repairs or adaptations are made to the product by third parties.
6. Defects ensuing from damage or accidents caused by external factors are excluded from the warranty.
7. If we replace any parts in accordance with the obligations ensuing from this warranty, the parts we replaced become our property.

## Table of Contents

INTRODUCTION .....	3
WARRANTY.....	5
TABLE OF CONTENTS .....	6
EC DECLARATION OF CONFORMITY FOR MACHINERY (COPY) .....	7
OVERVIEW OF SYMBOLS.....	8
PICTOGRAMS .....	9
<b>1. TECHNICAL INFORMATION.....</b>	<b>10</b>
<b>2. DESCRIPTION OF THE INSTALLATION.....</b>	<b>11</b>
2.1. DESCRIPTION OF THE MAIN COMPONENTS SA0026 .....	11
2.2. ELECTRICAL INSTALLATION .....	13
<b>3. SAFETY .....</b>	<b>14</b>
3.1. GENERAL.....	14
3.2. DURING NORMAL USE .....	15
3.3. OPERATING PERSONNEL.....	15
<b>4. INSTALLATION .....</b>	<b>16</b>
4.1. LOCATION.....	16
4.2. CONNECT THE MACHINE. ....	17
4.3. PREPARING FOR TRANSPORTATION.....	17
<b>5. OPERATION .....</b>	<b>18</b>
5.1. STARTING UP .....	18
5.2. PRODUCTION .....	19
5.3. HOOK UP THE FRONT LEG .....	20
<b>6. MAINTENANCE .....</b>	<b>21</b>
6.1. MAINTENANCE DIAGRAM .....	21
6.2. CLEAN THE MACHINE. ....	22
6.3. LUBRICATION OF REAR GATE.....	22
6.4. PARTS.....	23
<b>7. DISPOSAL AS WASTE .....</b>	<b>24</b>
<b>8. APPENDIX .....</b>	<b>25</b>
8.1. LOGBOOK .....	25
 <b>LIJST MET AFBEELDINGEN</b>	
FIGURE 1: OVERVIEW SA0026 .....	11
FIGURE 2: LOCATION OF CRUSH .....	16
FIGURE 3: DETAIL OF HOOKING UP FRONT LEG .....	20
FIGURE 4: LUBRICATION OF REAR GATE .....	22

## EC DECLARATION OF CONFORMITY FOR MACHINERY (COPY)

Manufacturer: Wopa Constructiebedrijf B.V.  
Address: Rector Hulshofstraat 10  
NL-7135 JV Harreveld  
The Netherlands  
+31-(0)544 372415  
E-mail: info@wopa.com  
Website: www.wopa.com



Declare that:

Machine: Treatment box  
Type number: SA0026  
Serial number: ...

- Complies with the provisions of the Machinery Directive 2006/42/EC, as last amended (including safety requirements of Low Voltage Directive 2014/35/EU) and the national legislation implementing this Directive.
- Where applicable also complies with the provisions of the following EC-Directives: EMC-Directive 2014/30/EU

Following (parts of) harmonized standards are applied:

- EN-ISO 12100:2010
- EN-ISO 13854:2019
- EN-ISO 13849-1:2016
- EN-ISO 60204-1:2018

Technical documentation can be applied for at the above address through management department.



The Netherlands - Harreveld,  
Date: \_\_\_\_\_

J.W.A. Wopereis  
Directeur

A handwritten signature in blue ink, appearing to be 'J.W.A. Wopereis', written over a horizontal line.





## Overview of symbols

The following symbols are used for all actions that jeopardise the safety of the user and/or technician and require caution.

	Attention!
	Hazard: High voltage!
	Tip: Offers quick insight or tips to carry out certain actions more easily and simply.

## Pictograms

A number of pictograms and alerts are affixed to the installation to indicate possible risks to users, among other things.

Pictogram	Description	Location
	<ul style="list-style-type: none"> <li>Type plate</li> </ul>	<ul style="list-style-type: none"> <li>On the machine frame</li> </ul>
	<ul style="list-style-type: none"> <li>Read the user manual</li> <li>Wear safety goggles when operating machine</li> <li>Wear hearing protection when operating machine.</li> </ul>	<ul style="list-style-type: none"> <li>On the machine frame</li> </ul>
	<ul style="list-style-type: none"> <li>Warning pictograms for mechanical and electrical hazards</li> </ul>	<ul style="list-style-type: none"> <li>On the machine frame</li> </ul>
	<ul style="list-style-type: none"> <li>Crushing hazard</li> </ul>	<ul style="list-style-type: none"> <li>By the rear gate, if present.</li> </ul>
	<p style="text-align: center;"><b>ATTENTION!</b></p> <ul style="list-style-type: none"> <li>Check regularly whether the pictograms and signs are still clearly recognisable and legible. Replace if this is no longer the case.</li> </ul>	

## 1. Technical information

	SA0026	
<b>General</b>		
Ambient temperature during operation	- 10 to 40	°C
Noise production	< 75	dB(A)
<b>Machine dimensions</b>		
Length	2100	mm
Width	1000	mm
Height	2300	mm
<b>Maximum product dimensions</b>		
Length	3000	mm
Width	1000	mm
Height	2900	mm
<b>Electrical connection (optional)</b>		
Power supply	1 phase / AC	-
National voltage	230	V
Fuse required	4.9	A
Connected load	0.75	kVA

\* see electrical diagram

## 2. Description of the installation

	<p><b>FUNCTION</b></p> <ul style="list-style-type: none"> <li>• This section gives an overview of the most important components and functions. If detailed information is available elsewhere in the manual, you are referred to the specific sections.</li> <li>• The design of your crush may differ from the figures below.</li> </ul>
---	---

### 2.1. Description of the main components SA0026

	<p><b>FUNCTION</b></p> <ul style="list-style-type: none"> <li>• The SA0026 were developed especially for dairy cattle hoof trimming in the barn.</li> </ul>
---	---

The main components of the crush are shown in the illustration below:

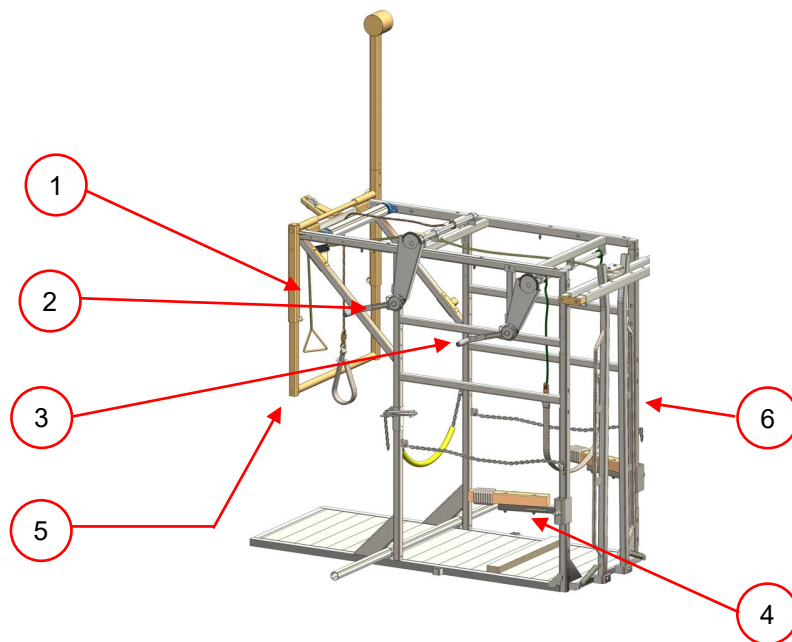



**Figure 1: Overview SA0026**

**Main components SA0026:**

Figure 1	Component	Description	See Section
1a	Front gate operating rope (SA0018)	<ul style="list-style-type: none"> <li>• Pulling on the rope closes the front gate.</li> <li>• The front gate can be opened at the front.</li> </ul>	
1	Front gate operating rope	<ul style="list-style-type: none"> <li>• Pulling on the rope closes the front gate.</li> <li>• If one wants to open it, the front gate can be unlocked by pulling the rope upward and back at an angle and then opened by slackening the rope.</li> </ul>	
2	Manual hind leg winch	<ul style="list-style-type: none"> <li>• After the strap is attached round the hind leg as shown in the photo above, the leg can be hoisted using the manual hoist so the hoof can be treated.</li> <li>• As an option, this operation can be done with an electric motor</li> </ul>	
3	Manual belly strap winch	<ul style="list-style-type: none"> <li>• Once the cow is moved into the crush, the belly strap is attached behind the front legs. The belly strap can be lifted using the manual hoist.</li> <li>• As an option, this operation can be done with an electric motor.</li> </ul>	
4	Front leg support	<ul style="list-style-type: none"> <li>• The cow's front leg can be secured to the front leg support with a rope so the leg can be treated.</li> <li>• Optionally, the crush can be equipped with a front leg support with a winch.</li> <li>• Another option is to equip it with a front leg support with electric winch.</li> </ul>	5.3
5	Rump bar	<ul style="list-style-type: none"> <li>• An alternative to the rump chain is the SA0026 equipped with a spring-loaded rump bar.</li> <li>• After the cow has been moved into the crush, the rump bar is pressed <b>tightly</b> to the back of the animal and secured to the crush with a chain (if the chain is too loose the cow can sit on its haunches).</li> </ul>	
6	Front gate	<ul style="list-style-type: none"> <li>• The front gate can be set to 3 positions using the operating rope:</li> <li>• Entirely open: the cow can exit the crush at the front.</li> <li>• Partially open: the cow can move its head through the front gate but not its shoulders. Stationary position.</li> <li>• Closed: the front gate is closed behind the animal's head.</li> </ul>	-

## 2.2. Electrical installation

	<p><b>FUNCTION</b></p> <ul style="list-style-type: none"> <li>• The electrical installation provides power to the electric winches and the sockets (as an option).</li> <li>• See the electrical diagram in the switch box on the crush for the rest of the structure and controls of the electrical installation included in the delivery.</li> </ul>
---	--

	<p><b>ATTENTION!</b></p> <ul style="list-style-type: none"> <li>• Work on the electrical installation can only be carried out by a technical expert.</li> </ul>
---	---

### The installation consists of the following components

	Component	Description	Section / location
1	Power supply cable with plug	<ul style="list-style-type: none"> <li>• To connect the machine to the power supply.</li> </ul>	
2	Relay box	<ul style="list-style-type: none"> <li>• A relay box is installed for each drive. It contains the control components of the relevant drive.</li> </ul>	
3	Control buttons	<ul style="list-style-type: none"> <li>• Each drive has 1 or 2 control panels to operate the following functions, depending on the version and/or the options available. <ul style="list-style-type: none"> <li>○ Front legs up/down</li> <li>○ Belly strap up/down</li> <li>○ Hind legs up/down</li> </ul> </li> </ul>	

## 3. Safety

### 3.1. General



- The guarantee will lapse and no liability will be accepted in the event of damage caused by repairs and/or modifications not authorised by the supplier.
- In the event of faults please contact the supplier.
- The working area around the installation must be safe. The owner of the installation must take the necessary precautionary measures in order to operate the installation safely.
- Starting up the installation in an area with a risk of explosion is prohibited.
- The installation has been so designed that production is safe under normal ambient conditions.
- The owner of the installation must ensure that the instructions in this manual are followed in practice.
- The safety features provided must not be removed.
- Correct operation and safety of the system can only be guaranteed where maintenance is carried out correctly and in good time, as prescribed.
- Where work is to be carried out on the installation it must be disconnected from the power supply, the power supply must be locked off and the system must be depressurised.
- There is a risk of trapping when operating driven moving parts. It is the operator's responsibility to ensure that the installation is only started up when no parts of his own or other people's bodies are in the vicinity of the trapping zone.



- Only authorised persons appointed by the owner may carry out work on the electrical installation.
- Ensure by means of internal procedures and supervision that all applicable power supplies have been switched off.
- The installation must not be used during cleaning, inspection, repairs or maintenance, and must be disconnected from the electrical supply by means of the plug and/or the main switch.
- Welding work must not be carried out on the installation unless the cable connection to the electrical components has first been disconnected.
- The power supply to the control cabinet must not be used for the connection of machinery other than the hand tools provided for.

### 3.2. During normal use



- Check before commencing operations that no work is being carried out on the installation and that it is ready for use.
- Unauthorised persons must not enter the operational area of the installation. It is the operator's task to check this.

### 3.3. Operating personnel



- Operating personnel must be aged 18 or above.
- Only authorised persons may carry out work with or on the installation.
- Only work for which proper training has been received must be carried out. This applies both to maintenance activities and normal use.
- The operating personnel must be familiar with all potential situations, so that rapid and effective action can be taken in an emergency.
- Where a member of operational staff observes defects or risks or is not in agreement with the safety measures, this must be reported to the owner or the manager.
- Safety footwear is mandatory.
- Suitable work clothing is mandatory.
- All employees must observe the safety instructions to avoid presenting a risk to themselves and others. Comply strictly with the operating instructions at all times.

## 4. Installation

	<p>EXPLANATION</p> <ul style="list-style-type: none"> <li>Consult the technical data and the circuit diagram provided for the correct specifications.</li> </ul>
---	--

### 4.1. Location

	<p>CAUTION</p> <ul style="list-style-type: none"> <li>The machine must be transported and installed upright.</li> <li>Place the machine on a level and stable substrate</li> <li>Take account of the instructions in Section 3 when carrying out any activity. Failure to follow these may lead to serious injury.</li> </ul>
---	---

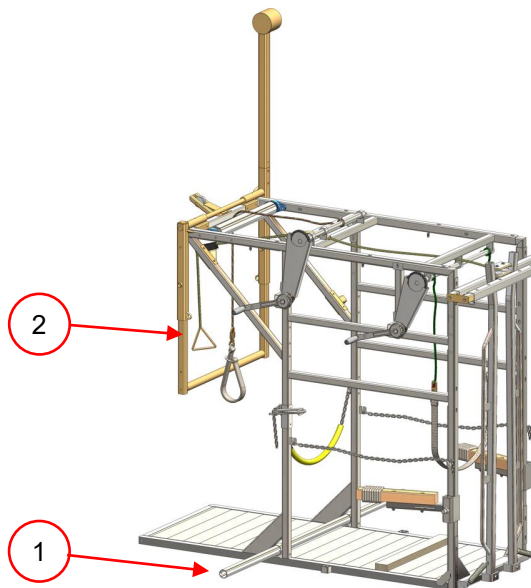



Figure 2: location of crush

No.	What to do	Action	Result
1.	Install the anti-tipping bar	<ul style="list-style-type: none"> <li>Slide the anti-tipping bar into the recesses in the crush to increase lateral stability.</li> </ul>	
2.	Open the front gate	<ul style="list-style-type: none"> <li>Open the front gate by operating the lever on top of the front gate.</li> </ul>	

#### 4.2. Connect the machine.

	<p style="text-align: center;">CAUTION</p> <ul style="list-style-type: none"><li>• Check that the voltage specified on the machine plate matches the mains supply.</li><li>• The machine must always be connected to an earthed socket to avoid the risk of fire or electric shocks (the earth connection is coded green/yellow).</li><li>• The electrical installation including the sockets must be connected in accordance with local regulations.</li><li>• The power cable must always be free and nothing must be placed on top of it.</li><li>• Replace the power cable immediately if it is damaged.</li></ul>
---	--

#### 4.3. Preparing for transportation.

	<p style="text-align: center;">CAUTION</p> <ul style="list-style-type: none"><li>• Preparing for transportation is the reverse procedure to making ready for use (see 4.1).</li></ul>
---	---

## 5. Operation



### CAUTION

- Take account of the instructions in Section 3 when carrying out any activity. Failure to follow these instructions may lead to serious injury.

### 5.1. Starting up

No.	What to do	Action	Result
1.	Switch on the power.	<ul style="list-style-type: none"><li>• Insert the plug in the socket.</li></ul>	

## 5.2. Production

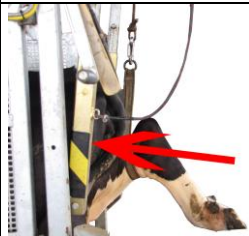
No.	What to do	Action	Result
1.	Check that the crush is ready for use.	<ul style="list-style-type: none"> <li>See Section 5.1.</li> </ul>	
2.	Place the front gate ready.	<ul style="list-style-type: none"> <li>Open the front gate so that the head of the animal can pass through but not its withers.</li> </ul>	
3.	Place the cow in the crush.	<ul style="list-style-type: none"> <li>Lead the cow into the crush until its head has passed through the front gate.</li> <li>Close the front gate.</li> </ul>	
4.	Attach the rump chain or rear gate.	<ul style="list-style-type: none"> <li>Lower the rear gate and secure it with the chain (SA0026).</li> <li><b>In order to avoid the risk of damage to the rear leg, ensure that the rear gate is pressed up tightly against the animal.</b></li> </ul>	
5.	Apply the belly belt	<ul style="list-style-type: none"> <li>Place the belly belt under the belly behind the front legs and tighten it.</li> <li>Where the (optional) electrical drive to the belly belt is present, the belt remains connected and is raised from the floor until it comes up under the belly.</li> </ul>	
6.	Process a rear hoof.	<ul style="list-style-type: none"> <li>Place the belt around the rear leg and raise the leg.</li> <li>Process the rear hoof.</li> <li>Allow the leg to drop and release it.</li> </ul>	
7.	Process a front hoof.	<ul style="list-style-type: none"> <li>Pass the long, soft rope around the front leg below the dew claw and pull the leg up to the block. Wrap it around a couple of times and fasten the end to the hook on the side of the support.</li> <li>Where the front leg support is provided with a winch the front leg is hooked on as shown in 5.3. Turn the winch until the leg is fixed to the block, then run the short tension rope past the knee of the front leg and fasten it to the side of the front leg support using the hook.</li> <li>Process the front hoof.</li> <li>Release the short tension rope.</li> <li>Pull the pin on the side winch towards the hand grip with the index finger to release the rope. Unhook the rope.</li> </ul>	See 5.3

No.	What to do	Action	Result
8.	Loosen the belly belt.	<ul style="list-style-type: none"> <li>Reverse the winch and loosen the belt, or:</li> <li>Allow the belt to drop to the floor (electrically, optional).</li> </ul>	
9.	Release the crush.	<ul style="list-style-type: none"> <li><b>Check that all ropes and belts have been freed.</b></li> <li>Open the front gate.</li> <li>Lead the cow out of the crush.</li> </ul>	
10.	Release the rump chain or raise the rear gate.	<ul style="list-style-type: none"> <li>Release the rump chain or raise the rear gate.</li> </ul>	

### 5.3. Hook up the front leg.



	<p>CAUTION</p> <ul style="list-style-type: none"> <li>To avoid injury to the front leg the rope must be applied correctly. (see Figure 3)</li> </ul>
--	--



Figure 3: detail of hooking up front leg

## 6. Maintenance

	<p><b>CAUTION!</b></p> <ul style="list-style-type: none"> <li>• Always disconnect the machine from the power supply by pulling out the plug. Where a hydraulic accumulator is present this must be depressurised.</li> <li>• Test the installation on completion of maintenance work or repairs to ensure that it can be used again safely.</li> <li>• Only trained technical personnel may carry out the maintenance activities described or repair work.</li> </ul>
---	---

### 6.1. Maintenance diagram

The diagram below shows the maintenance activities to be carried out.

Activity	note	Daily	weekly	Every 100 animals	Annually	Every 2 years	See Section
<b>General</b>							
Check on panic locks and hooks.	Renew where damage is visible.						
Check ropes and chains.	Renew where damage is visible.						
Check plugs, cables, controls and connections.	Alert a competent fitter where damage is visible.						
Check that the left and right front leg ropes are hanging at equal lengths.	Where these are driven by a single motor.						
<b>Cleaning</b>							
Clean the machine.							6.2
<b>Lubrication</b>							
Grease nipples on rear gate sliding section.	Bearing grease.						6.3
Other grease nipples.	Bearing grease.						

## 6.2. Clean the machine.

	<p>EXPLANATION</p> <ul style="list-style-type: none"> <li>• A high-pressure cleaner may be used for cleaning.</li> <li>• Avoid bearings, winches and motors when cleaning with a high-pressure cleaner. Spraying in these areas may result in a sharp reduction in service life.</li> <li>• Avoid all electrical components when cleaning with a high-pressure cleaner. Spraying in these areas may result in risk of electric shocks and /or a sharp reduction in service life.</li> </ul>
---	---

## 6.3. Lubrication of rear gate

	<p>EXPLANATION</p> <ul style="list-style-type: none"> <li>• The rear gate is slid out with the aid of gas springs fitted to the gate.</li> <li>• To prevent grease entering the gas springs and causing damage, the gate must only be lubricated when it is fully drawn back.</li> </ul>
---	--



1

2

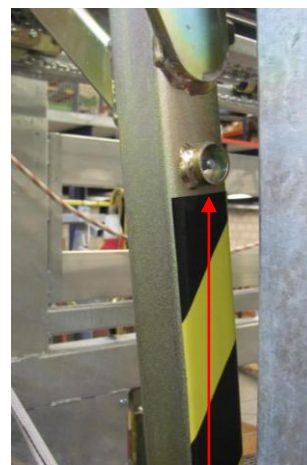

3

Figure 4: lubrication of rear gate

No.	What to do	Action	Result
1.	Retract the rear gate.	<ul style="list-style-type: none"> <li>• Attach the rear leg winch to the rear gate and tighten until the gate is fully retracted.</li> </ul>	
2.	Grease the nipples.	<ul style="list-style-type: none"> <li>• Lubricate the rear gate nipples using a grease gun.</li> </ul>	

## 6.4. Parts

	<p style="text-align: center;">EXPLANATION</p> <ul style="list-style-type: none"><li>• Consult the website at <a href="http://www.wopa.com">www.wopa.com</a> for information on the available options and the parts available to order.</li></ul>
---	---

## 7. Disposal as waste

Oil and components must not be disposed of as domestic waste. When replacing components or oil or at the end of the machines service life, ensure that all materials are collected and destroyed or reused in a legal and environmentally friendly manner.





